

The world of mobility - welcome to ThyssenKrupp Access Solutions



Engineering Tomorrow Together

We specialise in transforming the vision you have of your home into reality.

Our home lifts offer a near-limitless number of options that allow you to hand-pick every colour, texture and accessory to make your home lift truly unique, reflecting your identity in every single detail.

Introducing the H300 by thyssenkrupp.

Our distinctive approach to offering the best solution for your home has led us to develop a truly global home lift. Available in a range of technologies, each widely used around the world, we are confident that we can offer you a configuration that will not only fit, but is right for you.

Security, reliability, and ease of use are the pillars of our design, which are delivered from the components we use and our attention to every single detail. Individual tailor-made projects that comply with the highest quality and safety standards, allow each cabin to feel unique yet familiar at the same time.

H300

Elevator Technology

Living at its best.

H300, a truly global home lift.



thyssenkrupp





Designed with you in mind

You can choose satin and scratch-resistant steel, or textured and plain finish modern walls, or opt for the vivacity of the infinite colours of the RAL range, in a game where releasing your imagination will be simple.

Have fun with the numerous combinations available.

With the thyssenkrupp home lifts, you can finally treat yourself to all the style and comfort that you want, enhancing your environment with an extremely captivating and contemporary design object.

H300

You aspire. We deliver.

The H300 offers a wide range of materials and colours for the cabin walls. Further options are available as an optional

Platform wall colours.



Cabin flooring.



Cabin



Central Panel.



Platform wall colours.

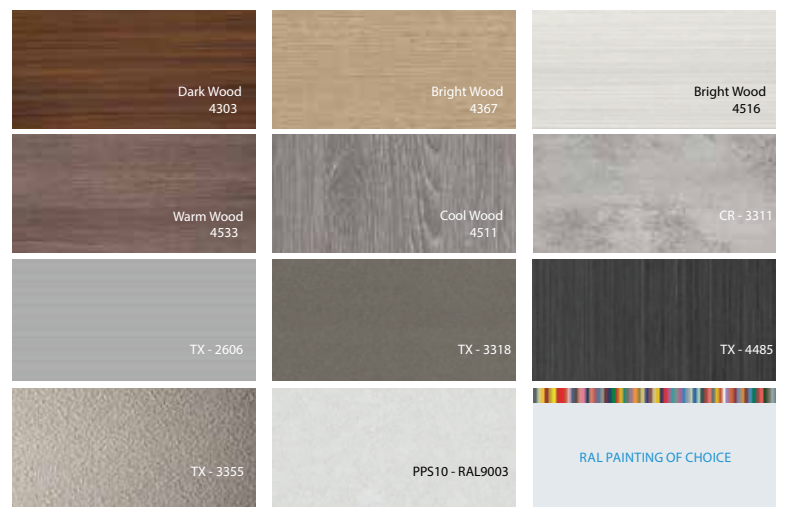

Cabin flooring.

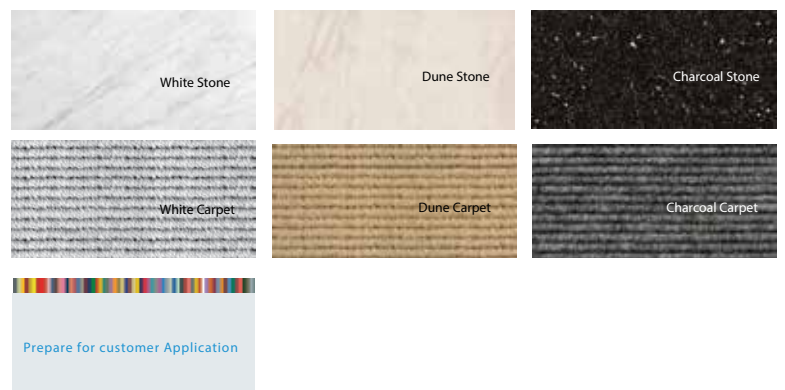

Cogbelt

Interiors

Control Operation Panel



Ceiling and lighting.



As standard each home lift comes with the Steel floating ceiling with LED lights



Maximise the light available when you choose to the Opal ceiling with LED lights.



As an option, choose the Round Ceiling and LED lights as a unique design element.



As an option, choose the Round Ceiling and LED lights as a unique design element.

Cabin and landing doors.



H300 specification

The closest thing to a elevator in your home

Technical compliance	Machine Directive 2006/42/EC EN81-41/SIL 3
Drive system	Gearless with cogbelt drive
Rated speed	0.15 m/s up to 0.50 m/s
Rated load	Up to 400 kg
Travel height	Up to 18,00mm
Number of stops	Max. 6 stops per lift
Number of doors	Max. 12 doors per lift
Pit	140 mm (no pit is required in case of threshold/ramp)
Shaft top height	2500 mm in existing shaft / 2600 with its own shaft
Platform control	Automatic (one-touch) with call reservation
Environment	Indoor / Outdoor
Emergency lowering	Battery operated emergency lowering
Control voltage	24V

Perfect synthesis between form and function.

Gulliver

Gulliver and Orion are elevators that adapt to your needs. Carefully designed layouts and high-tech components meet the criteria of absolute quality. With Gulliver and Orion you can finally treat yourself to all the style and comfort that you want, enhancing your environment with an extremely captivating and contemporary design object. Compact and functional, they are designed to be inserted in any environment because each elevator is custom designed and built.

Gulliver and Orion are available in two models, Orion for masonry shaft or Gulliver with a complete metal structure. Masonry shaft application allows you to camouflage the elevator leaving only the doors visible: sliding automatic or swing, blind or panoramic. The metallic structure will become an element of design within the environment. Inside and out, the hot galvanised structure, will withstand the most extreme environmental conditions.



& Orion

Orion with Masonry Shaft



Gulliver with Shaft



Orion Sliding Doors



Gulliver Sliding Doors

Mobility that adjusts.

Gulliver & Orion

Energy efficient in use, you can of course use the lift to get not only you from one floor to another but also for shopping, laundry, furniture etc. Gulliver and Orion easily fit into an existing space, such as a closet or in the hall beside the stairs. Our individual solutions offer an ideal combination with your personal living concept, providing you an increased quality of life.



CABIN WALLS / SKIN PLATES

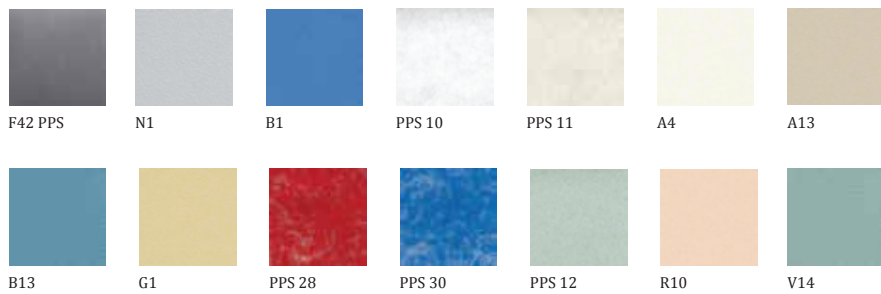

LIGHTING SYSTEMS



SHAFT PROFILES



CABIN WALLS / STAINLESS STEEL

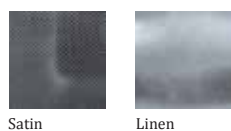

CABIN FLOOR / PVC



HANDLES



CLASSIC

Chrome-plated brass or gold effect

MODERN

Stainless Steel effect

TECHNO

Satin Stainless Steel

SHAFT AND PANELS



OUTER SHAFT VIEW



INNER SHAFT VIEW



Smokey Grey

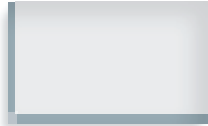

Smokey Satin



Transparent

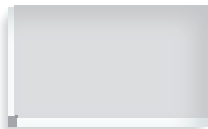

Opaline



Half Reflecting

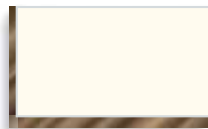

Abet or MDF White

FLOOR AND CABIN DOORS



STEEL RAL PAINTED SWING DOORS
All the RAL colours. Blind, with a window or panoramic.



STAINLESS STEEL SWING DOOR
Satin, lino effect, checks or scotch brite. Blind, with a window or panoramic.



ALUMINIUM SWING DOOR
Natural anodised, bronze effect or nickel effect. Panoramic.



ALL-GLASS SWING DOOR
Crystal. Panoramic.



WOODEN SWING DOOR
Oak, mahogany, walnut or chestnut. Blind.



EI FIRE-RESISTANT SWING DOOR
Blind. 60 or 120 minutes



SLIDING AUTOMATIC
RAL painted, satin stainless steel, skinplate



FOLDING AUTOMATIC
RAL painted, satin stainless steel or lino effect

Automatic sliding or folding doors, allow you to have automatic controls from inside the cabin, for operation identical to that of a traditional elevator.

DATA SHEET ORION

Installation In masonry shaft with internally smooth shaft wall
Car layouts Platform with roof Basic cabin Cabin with automatic doors
Run Max 15.1 meters (platform only, cabin max 12 meters) Number stops max 6
Power supply 230 ± 10% V, 50 Hz single phase with ground conductor
Motor Single phase 230 V, 50 Hz; 1.8 -2.2 Kw
Capacity Max 400 Kg
Speed 0,15 m/s with soft start / stop
Guide T 70 section
Width Minimum wall 660 mm
Movement Lifting by means of hydraulic cylinder with stem and take-up chains
Controls "Hold to run" or "Automatic control" (enclosed cabins only)
Safety devices Emergency stop button on board Locks with safety switches for door closing Auxiliary electrical system in case of power failure with return to floor and door release Instantaneous overspeed governor Load control device Limit switches with automatic floor levelling
Compliance EC, TUV, corresponding to M.D. 236/89 EN 81-41* Machinery Directive 2006/42/EC EMSD Section E, Part 6* AS 1735. 15 Person restrict use non auto controlled AS 1735. 16 Person restrict use auto controlled AS 1735. 15-2002 *Hold to run only



DATA SHEET GULLIVER

Installation Shaft frame consists of cold folded galvanized steel Sheeting powder coated in RAL
Shaft Cladding Made with VISARM 10/11 shatter-proof glass or with blind panels
Car layouts Platform with roof Basic cabin Cabin with automatic doors
Run Max 15.1 meters (platform only, cabin max 12 meters) Number stops max 6
Power supply 230 ± 10% V, 50 Hz single phase with ground conductor
Motor Single phase 230 V, 50 Hz; 1.8 -2.2 Kw
Capacity Max 400 Kg
Speed 0,15 m/s with soft start / stop
Guide T 70 section
Width Minimum 730 mm
Movement Lifting by means of hydraulic cylinder with stem and take-up chains
Controls "Hold to run" or "Automatic control" (enclosed cabin only)
Safety devices Emergency stop button on board Locks with safety switches for door closing Auxiliary electrical system in case of power failure with return to floor and door release Instantaneous overspeed governor Load control device Limit switches with automatic floor levelling
Compliance EC, TUV, corresponding to M.D. 236/89 EN 81-41*, Machinery Directive 2006/42/EC EMSD Section E, Part 6* AS 1735. 15 Person restrict use non auto controlled AS 1735. 16 Person restrict use auto controlled AS 1735. 18-2002 *Hold to run only



Elegance

Stainless Steel



Tobacco



Azur



Writable

Cabin

Dark



Panoramic



Light



Shaft Indoor

Elegance Cabin - Finishes

Cabin Coner (or) Corner Satin

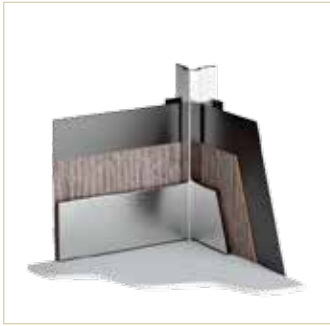

Cabin Coner Mirror

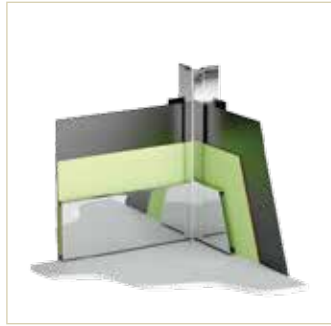

Cabin Coner Gold Mirror

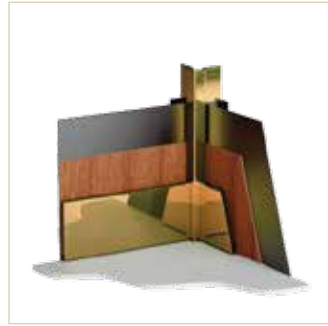

Elegance Cabin - Finishes

Home Elevators / Vertical platform lifts

STAINLESS STEEL

For cabin inner walls, cabin elements and finishes of sliding automatic doors.

Cabin elements are: Central Panel, horizontal baseboard, vertical profiles, ceiling frame.



Inox Satin



Inox Mirror



Inox Gold Mirror

LAMINATES - PLAIN COLOURS

For cabin inner walls.



405 - Porcelain White



411 - White



414 - Sand



463 - Pom Pom Yellow



861 - Pop Yellow



441 - Cedar Green



858 - Pervinca Azur Blue



472 - London Grey

MAGNETIC

For cabin inner walls.

Magnetic sheets are used as display panels for setting magnets in the didactics and communication field. The Grey 879 colour is proposed as common chalk-blackboard; the White 406 colour can be used as display panels for dry-markers.

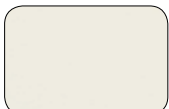

406 - Magnetic Cream



879 - Grey

LAMINATE WOOD

For cabin inner walls.

The Wood collection offers a variety of new opportunities to those architects and designers seeking a technical material with the performance of laminate, whilst maintaining the warmth and variety of wood, with a surprising visual richness and tactility.



358 - Crea Walnut



381 - Douglas Vanilla



383 - Europe Oak



387 - Douglas



338 - Douglas Ice

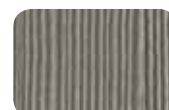

606 - Arctic Pine



656 - Tennessee Oak



1381 - Trasversal Oak



1382 - Trasversal Tobacco



1609 - Pavese Cherry



1611 - Fey Cherry



1636 - Italian Walnut

Elegance Cabin - Finishes

LAMINATES - METAL LIKE

For cabin inner walls.

Material consisting of layers of paperboard impregnated with thermosetting resins and of a surface sheet of anodised aluminium, bonded together by means of heat and high pressure.



880 - Mirror S.Steel like



881 - Gold Mirror S.Steel like



1920 - Saturn Titanium



1921 - Venus Titanium

Elegance Cabin - Finishes

Home Elevators / Vertical platform lifts

FLOOR

PVC



Black



Grey



Ice



Sand

ROCKSOLID



Maltese Black



Dove Tail



White Star



Sunset Beach

OTHER

Prepared
for
customer
application

CEILING

Suspended ceiling with LED lighting in three different configurations.

Metal elements in the same finishes as cabin elements (Satin; Mirror; Gold Mirror).



Plain Steel



Opal



Starry Sky

Freedom and active living ...

Flow

Flow Stairlift fits most staircases, straight, around corners or even spiral, on either side of the staircase. This compact Stairlift looks simple on the outside but the technology on the inside is extremely ingenious.

Patented unique ASL (Advanced Swivel and Levelling) Technology allows an installation on the narrowest stairs while maintaining a comfortable chair size. With the arm and foot rests folded, Flow takes up little space when parked, and can even be parked "round the corner". Thanks to the vertical start options, Flow can also be used with only minimum space available in front of the first step, keeping doors and doorways free. Installed within a few hours, the Flow is your answer to years of freedom and extended quality of life.

The Flow stairlift has achieved many prestigious industry awards for design and innovation and is the number 1 stairlift in terms of quality and value for money.

- Adjusted to your height
- Patented Swivel Technology
- Discreet, foldaway design
- A range of upholstery options
- Quick and efficient installation



Thanks to proven monorail concept and patented ASL Technology the Flow rotates to the most optimal and safe position during the ride.



When the lift is folded up, there is still plenty of space for other stair users.



Different vertical start options enables installations even closer to doors.

Dimensions Flow

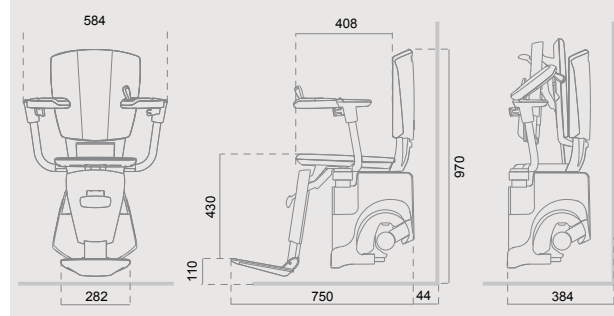

where not directly specified, measurements are in millimeters

... in your own
four walls.

Levant

Levant chairlift has been specially developed for straight staircases. With its modern chair and rail design and its reliable technology it is ideal for use in private households.

The entry model of the Levant chairlift range is introduced in 2008 and has been awarded with two design awards. A special Levant model for outdoor application is also available. With its reasonable price, Levant provides excellent value for money. Levant, standard equipped with manual swivel, has several options like padded seat, heavy duty drive, intermediate park position and a hinged rail.

- Space-saving folding seat
- Rail is fitted to the stairs and not on the wall
- Stable, ergonomically shaped arm rests with integrated retractable seatbelt
- Optional call and send stations
- Quick and efficient installation
- Outdoor model available



The hold-to-run joystick ensures easy and safe operation.



The aluminium rail has a slim design which gives the Levant a modern look. When the lift is folded up, there is still plenty of space for other stair users.

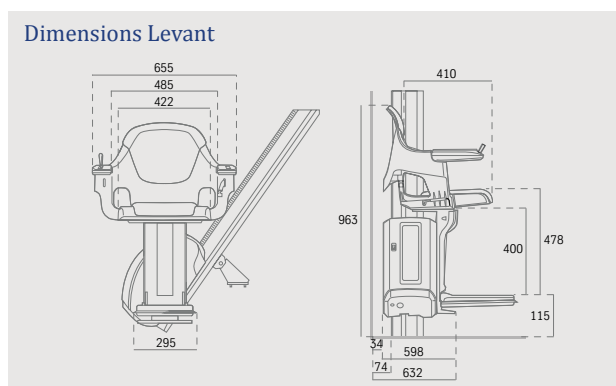

measurements are in millimeters



Remote call and send station with push button for more comfort.



The automatic hinged rail for installations close to doorways or corridors.



elite
ELEVATORS

ELITE ELEVATORS

k.Ramanathan & Co., Nibav Building, 2nd Floor, No:11, LB Road, Adyar, Chennai - 20.
info@EliteElevators.com | www.EliteElevators.com
M : +91 9361 61 3131 / 9344 33 0000